

2-electrode Gas Discharge Tubes

H2R12-800XE

1: Applications

- AC Power line N-PE applications
- Class I and Class II Surge protection



2: Dimension in mm

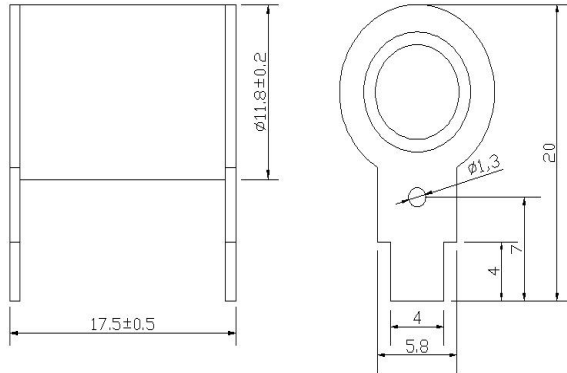

## Specification of H2R12-800XE

Dc spark-over voltage (100V/s)	1)	> 600V
Impulse spark-over voltage ( 1.2/50us, 6KV)		< 1500V
Breakdown time		< 100ns
- typical values		< 20ns
Insulation resistance @DC250V		10000MΩ
Class I according to IEC 61643-11		
Max continuous operating voltage at 50/60 Hz	Uc	264V
Nominal discharge current 8/20μs	In	20KA
Impulse current 10/350μs	Iimp	8KA
Follow Current at 50/60Hz at 264V	If	100A
Class II according to IEC 61643-11		
Max continuous operating voltage at 50/60 Hz	Uc	264V
Nominal discharge current 8/20μs	In	20KA
Maximum discharge current 8/20μs	I <sub>max</sub>	40KA
Follow Current at 50/60Hz at 264V	If	100A
AC discharge current (TOV at 1200V ,1 operation 50Hz,0.2 s)		300A
capacitance at 1MHz		< 4pF
Weight		~ 8g
UL 1449 Certification	On the UL List	
Delivery time		20days
Operation and storage temperature		-40℃ ... +90℃
Marking, Green	2R 800 YY	800 - Nominal voltage YY - Year of production

### 3:Application Figure



#### What can we do for our GDT?

- 1: We Can customize voltage: 230V,500V,800V...etc
- 2: We Can developed low impulse GDT
- 3: We Can customize  $U_c, I_n, I_{max}, I_{imp}, I_f, TOV$ .
- 4: We Can developed cut off follow current 100A within 1 cycle when passing zero under AC260V(50Hz)
- 5: We Can customize multi-gap GDT used in DC or AC(L-N) over voltage protection
- 6: We Can customize GDT shape, marking, special Lead wire
- 7: We Can surpass our GDT competitors, help you pass the GDT test project & improve the GDT you currently use.
- 8: We can provide fast GDT delivery, Solve your GDT delivery time problem
- 9: We can help you analyze the competitor's parameters and tell you our perfect replacement GDT part number.