

Gas Discharge Tubes

H2R16-800xx

1: Applications

- AC Power line N-PE applications
- Class I and Class II Surge protection



2: Dimension in mm

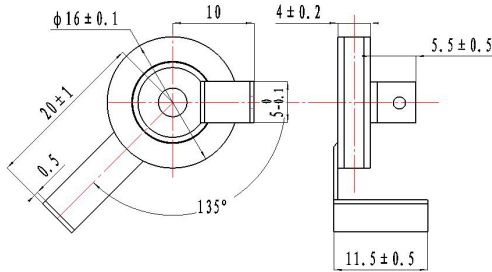

Specification of H2R16-800xx

Dc spark-over voltage (100V/s)	1)	> 600V
Maximum impulse spark-over voltage	5KV/μs (1.2/50us, 6KV)	1500V
Breakdown time		< 100ns
- typical values		< 20ns
Insulation resistance @DC250V		1000MΩ
Class I according to IEC 61643-11		
Max continuous operating voltage at 50/60 Hz	Uc	255V
Nominal discharge current 8/20μs	In	30KA
Impulse current 10/350μs	Iimp	6KA
Follow Current at 50/60Hz at 255V	If	100A
Class II according to IEC 61643-11		
Max continuous operating voltage at 50/60 Hz	Uc	255V
Nominal discharge current 8/20μs	In	30KA
Maximum discharge current 8/20μs	I _{max}	60KA
Follow Current at 50/60Hz at 255V	If	100A
capacitance at 1MHz		< 5pF
Weight		~ 5g
UL 1449 Certification		
On the UL List		
Delivery time		20days
Operation and storage temperature		-40°C ... +90°C
Marking, Blue	2R800 YY	800 - Nominal voltage YY - Year of production
1) At delivery AQL 0.65 level II Military Standard 105E.		
2) Test according to IEC 61643 11		

3:Application Figure

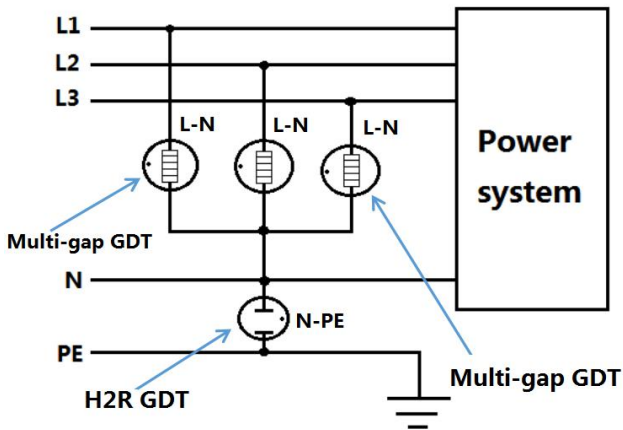

What can we do for our GDT?

- 1: We Can customize voltage: 230V,500V,800V...etc
- 2: We Can developed low impulse GDT
- 3: We Can customize $U_c, I_n, I_{max}, I_{imp}, I_f, TOV$.
- 4: We Can developed cut off follow current 100A within 1 cycle when passing zero under AC260V(50Hz)
- 5: We Can customize multi-gap GDT used in DC or AC(L-N) over voltage protection
- 6: We Can customize GDT shape, marking, special Lead wire
- 7: We Can surpass our GDT competitors, help you pass the GDT test project & improve the GDT you currently use.
- 8: We can provide fast GDT delivery, Solve your GDT delivery time problem
- 9: We can help you analyze the competitor's parameters and tell you our perfect replacement GDT part number.